

# Vitrium

# # VT 7651

## Mounting instructions

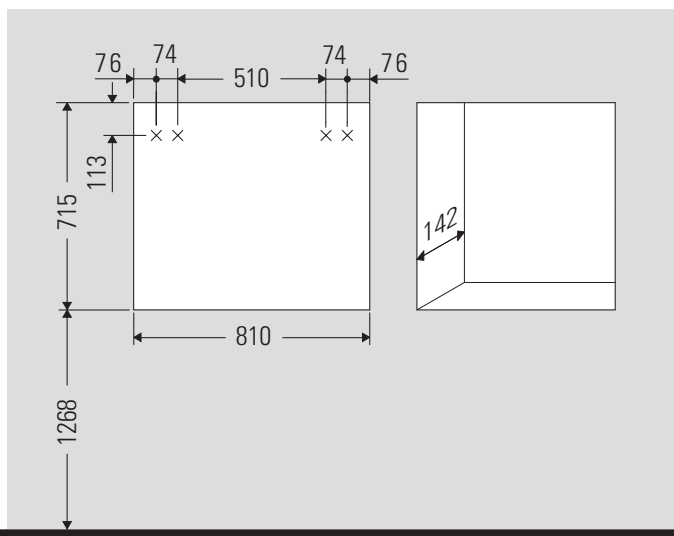
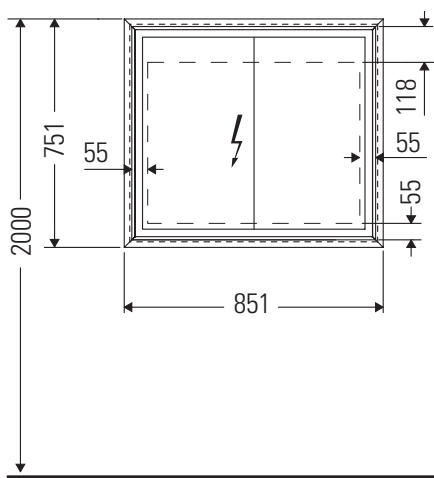

Cutout dimensions for built-in cabinets

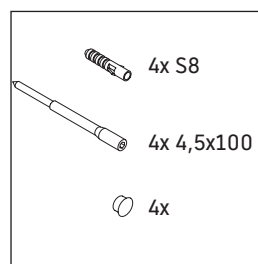
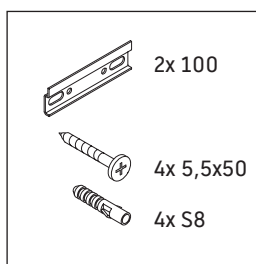
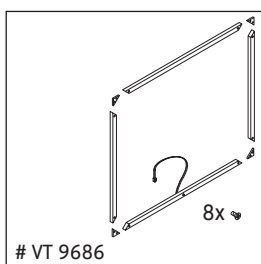
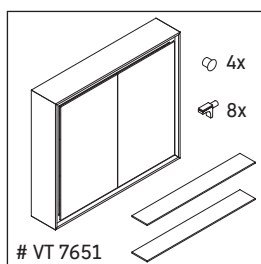

Please observe the mounting instructions for bathroom furniture with a power supply.

### Instructions for use

The bathroom furniture range complies with the standards and guidelines applicable at the time of delivery and is designed for use in bathrooms. Direct contact with water should be avoided, for example, when showering.

A power supply of 110 V – 230 V must be available on site.

We reserve the right to make technical improvements and design modifications to the products illustrated.



# VT 9686

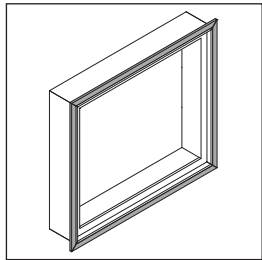

**1** # VT 9686

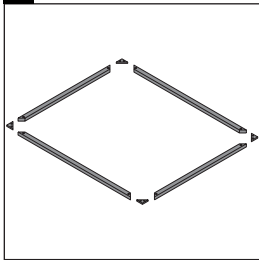

**2** # VT 9686

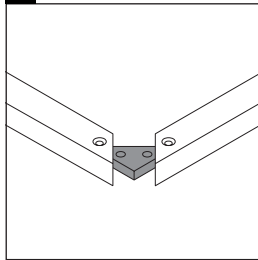

**3** # VT 9686

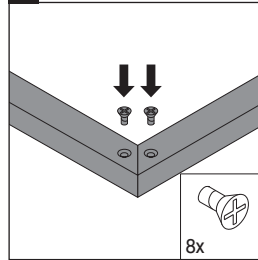

**4**

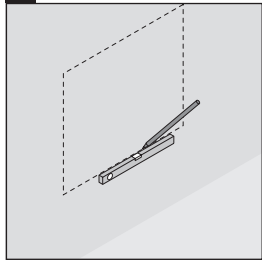

**5**

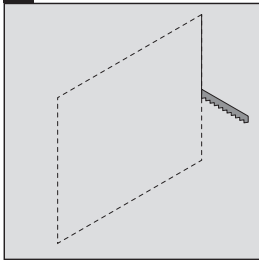

**6**

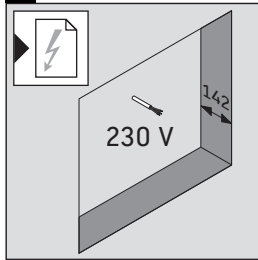

**7**

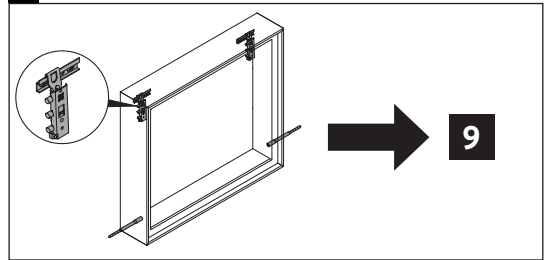

**8**

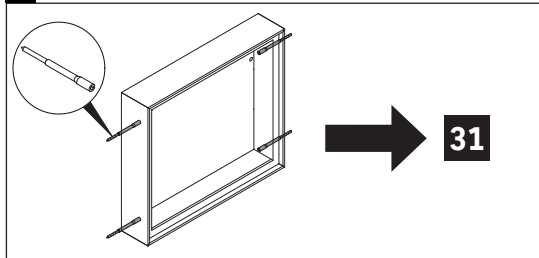

**9**

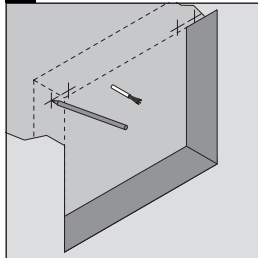

**10**

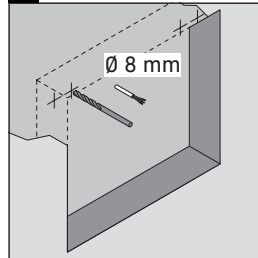

**11**

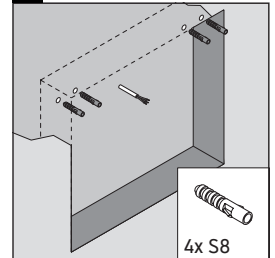

**12**

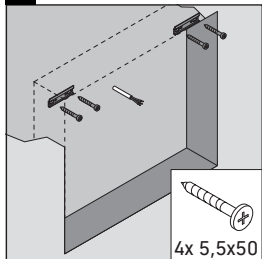

**13**

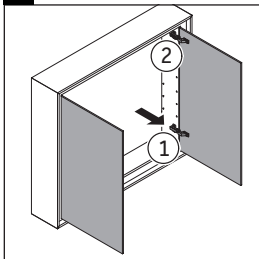

**14**

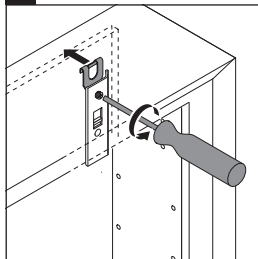

**15**

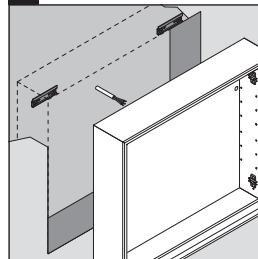

**16**

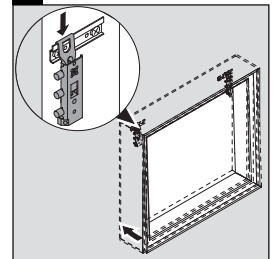

**17**

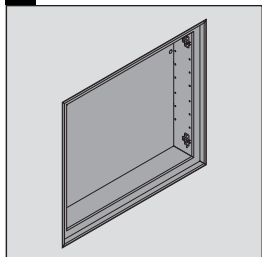

**18**

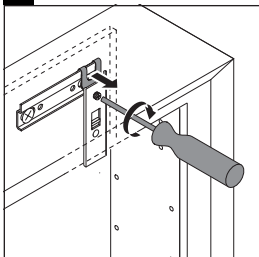

**19**

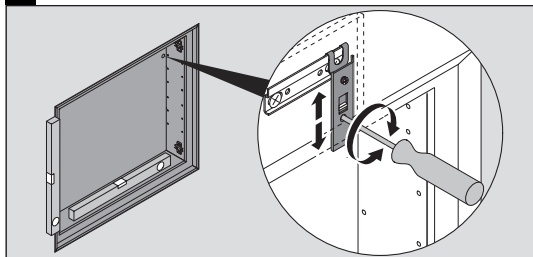

**20**

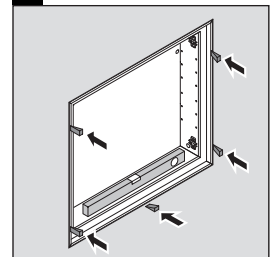

**21**

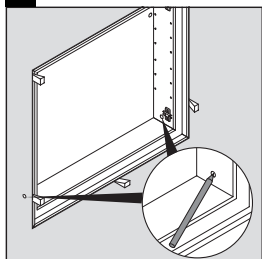

**22**

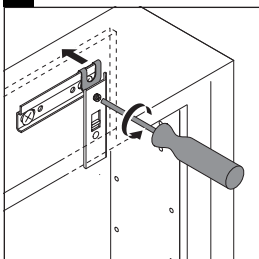

**23**

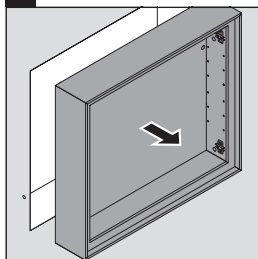

**24**

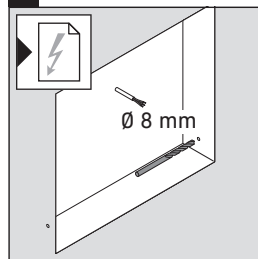

**25**

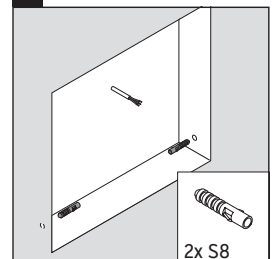

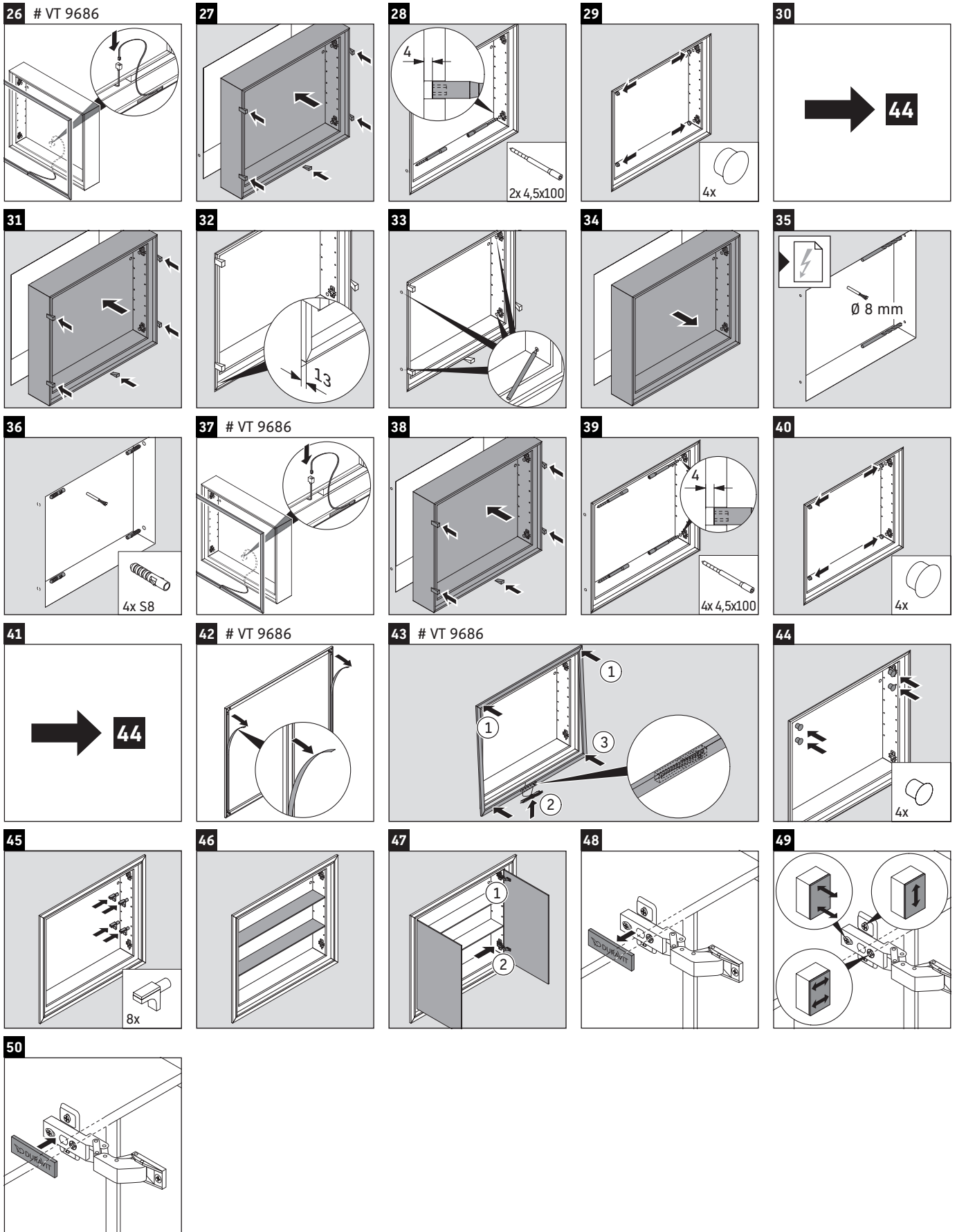



**1** # VT 9686

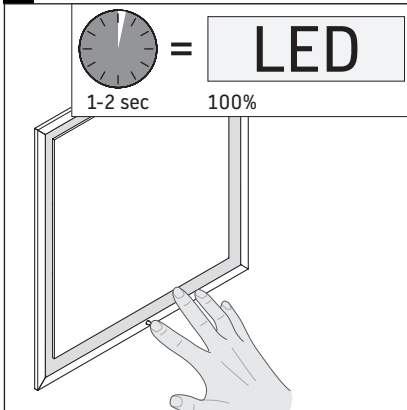

**2**

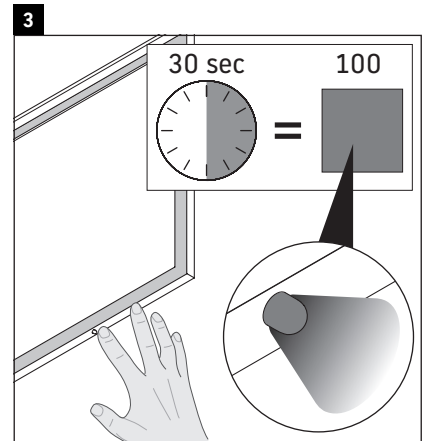
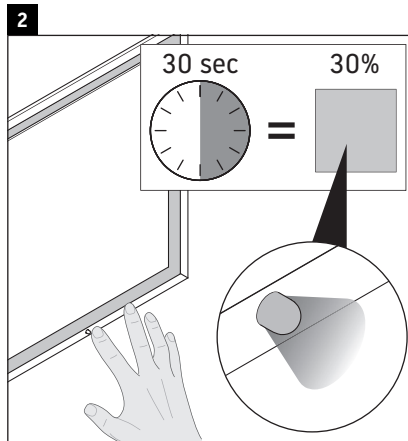
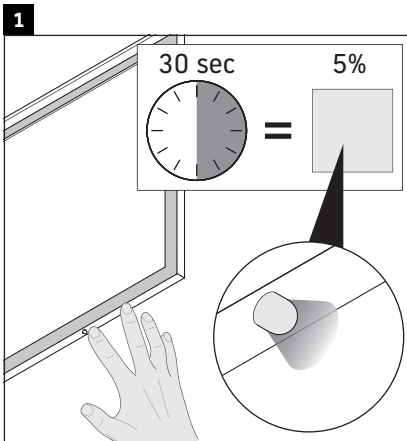
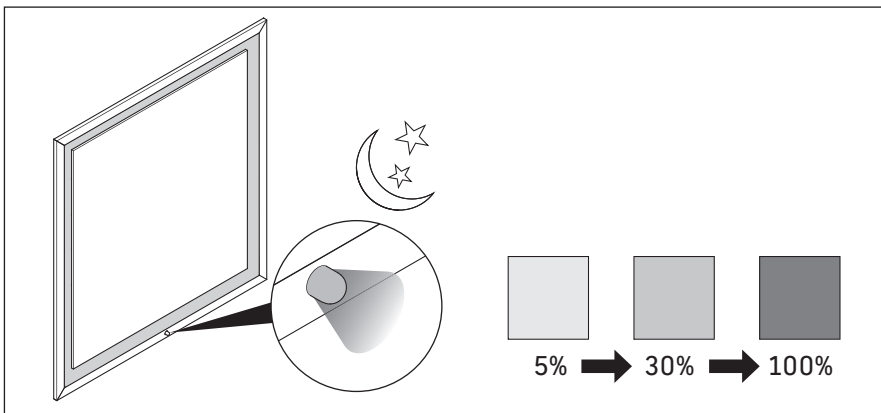
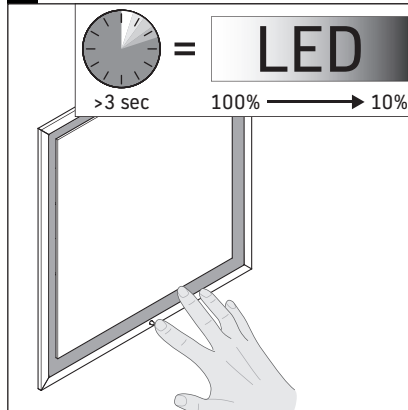

---

## **Mounting instructions**     for bathroom furniture with a power supply



Safety

2



Electrical installation

3



## Safety

### Intended use

The mounting instructions come as part of the Duravit product and are aimed at people who carry out the electrical installation for the product. You must read through the mounting instructions carefully and they must be available at all times.

### Target readership and qualifications

The electrical installation may only be carried out by qualified electricians.

### Protection rating of Duravit products

The protection rating of Duravit products with a power supply complies with the IP 44 standard as a minimum.

### Protection class of wall lights

| Protection class | Connecting cable                 |
|------------------|----------------------------------|
| I                | H05VV-F, 3x 1.5 mm <sup>2</sup>  |
| II               | H03VV-F, 2x 0.75 mm <sup>2</sup> |

### Standards and directives

Duravit products comply with the CE marking directives:



### Icons and symbols

| Symbol | Meaning         |
|--------|-----------------|
| >      | Action required |

### Disposal

- Do not dispose of the product in household waste. Products with this symbol must be disposed of in accordance with the WEEE Directive through local collection points for waste electrical equipment.



### Safety instructions

#### Danger to life

Contact with electricity may lead to an electric shock.

- > Carry out the electrical installation in accordance with the national, European and international directives and standards.
- > Observe protection zones for wet rooms in accordance with country-specific standards, local regulations and low voltage guidelines.
- > Connect the electrics using a ground fault circuit interrupter (GFCI) in wet rooms or other specially equipped rooms.
- > Disconnect electrical components from the power supply before the installation.
- > Check that all components are de-energised.
- > Prevent the power supply from being switched on accidentally.

#### Penetration of foreign bodies and water

Foreign bodies or water in equipment lead to a short circuit that may cause damage to the product.

- > Observe the protection zones for Duravit products.

#### Protection zones

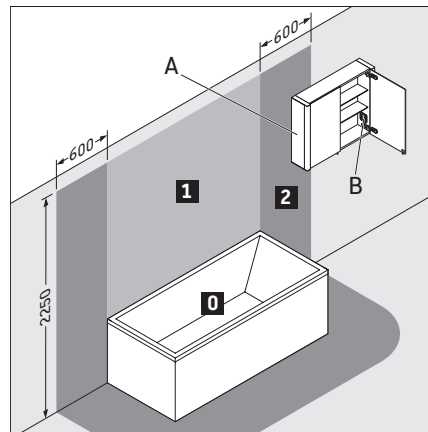

- A** A mirror cabinet with an IP 44 rating may protrude into zone 2.
- B** A socket in a mirror cabinet must be mounted outside the zones.

### Energy efficiency class

- This product contains an energy efficiency class F light source.



# Electrical installation

## Electrical installation for protection class I

### Electrical connection

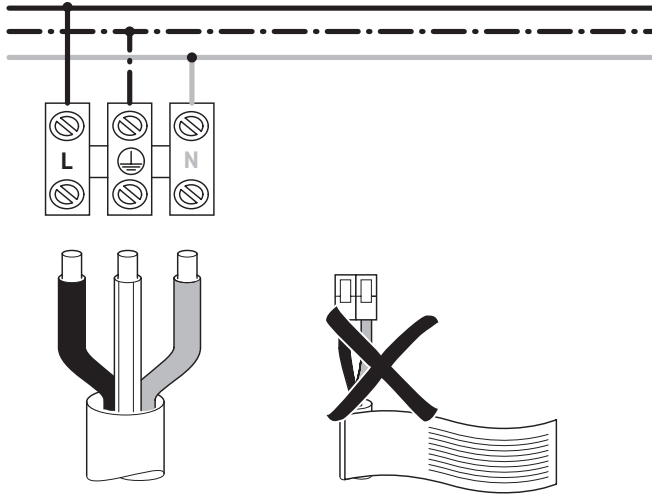

### Optional connection of an external button

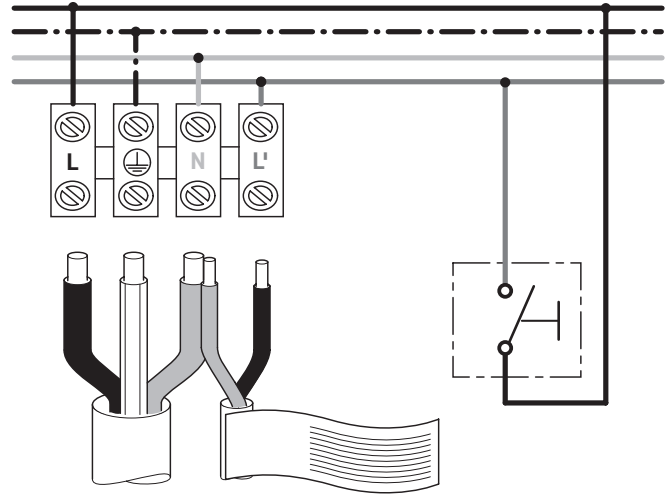

## Electrical installation for protection class II

### Electrical connection

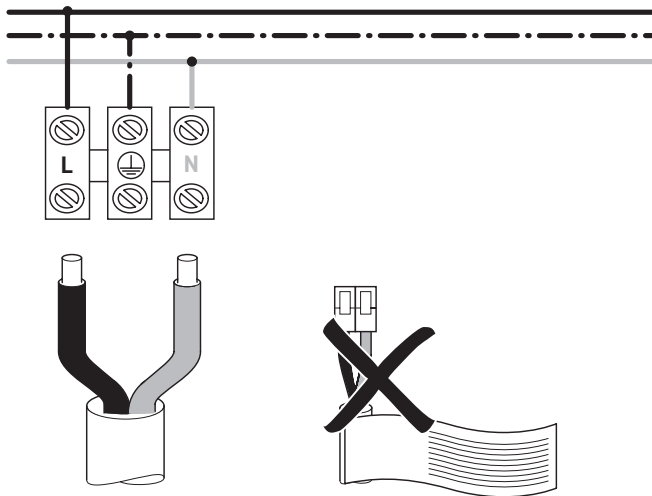

### Optional connection of an external button

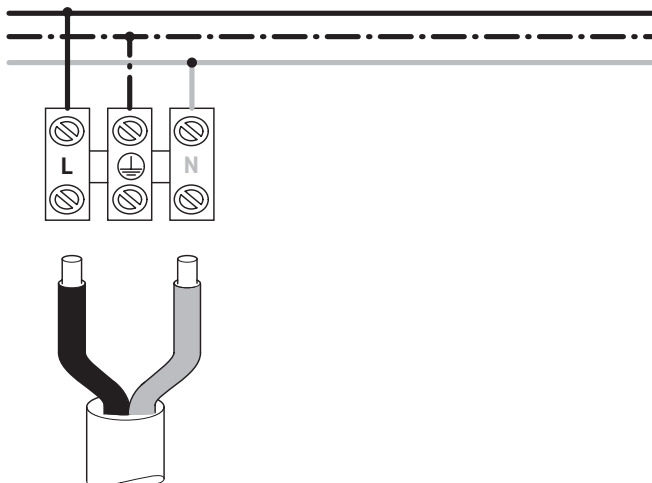
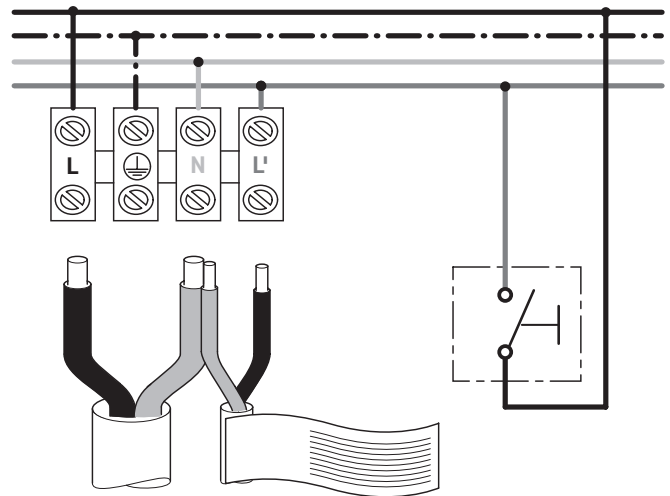

**DURAVIT AG**  
P.O. Box 240  
Werderstr. 36  
78132 Hornberg  
Germany  
Phone +49 7833 70 0  
Fax +49 7833 70 289  
info@duravit.com  
www.duravit.com

