

L-Cube

LC 106C

Mounting instructions

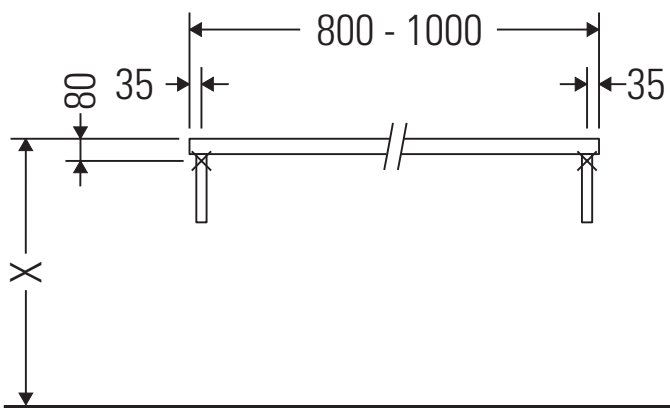

Follow all other installation instructions!

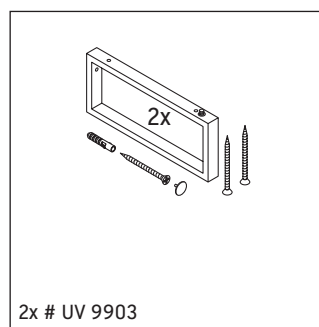

2x # UV 9903

Instructions for use

The bathroom furniture range complies with the standards and guidelines applicable at the time of delivery and is designed for use in bathrooms.

Direct contact with water should be avoided, for example, when showering.

The console is not suitable for installation from below with semi built-in and built-in washbasins.

Ceramics wider than 600 mm must be fixed to the wall.

We reserve the right to make technical improvements and design modifications to the products illustrated.



L-Cube

LC 106C

Mounting instructions

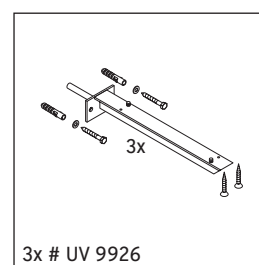
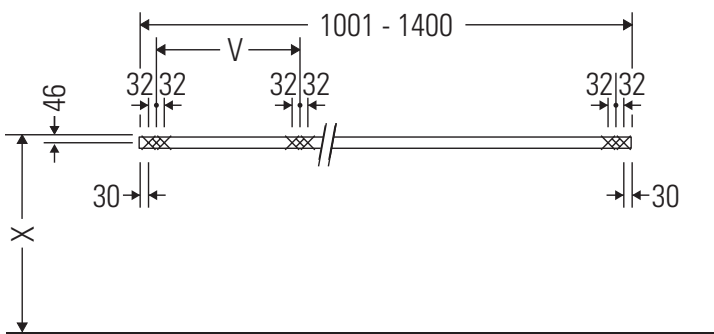
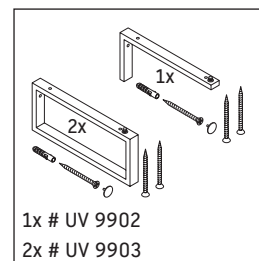
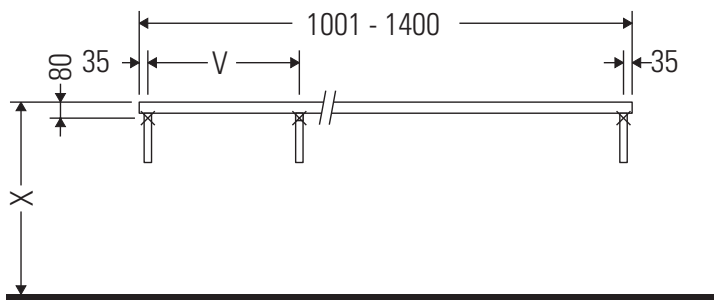
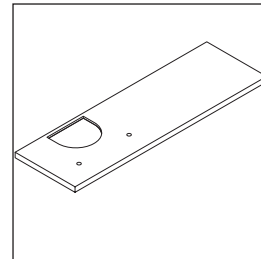
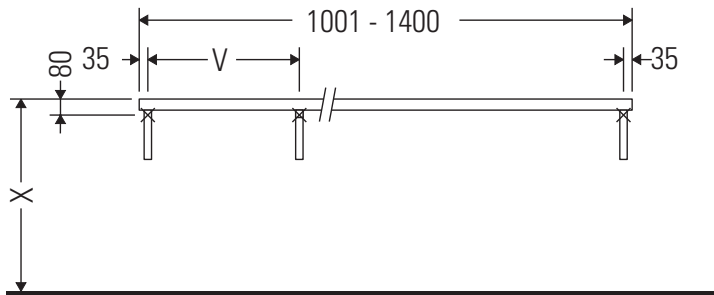

V = according to the panel specification



Follow all other installation instructions!

Instructions for use

The bathroom furniture range complies with the standards and guidelines applicable at the time of delivery and is designed for use in bathrooms.

Direct contact with water should be avoided, for example, when showering.

The console is not suitable for installation from below with semi built-in and built-in washbasins.

Ceramics wider than 600 mm must be fixed to the wall.

We reserve the right to make technical improvements and design modifications to the products illustrated.

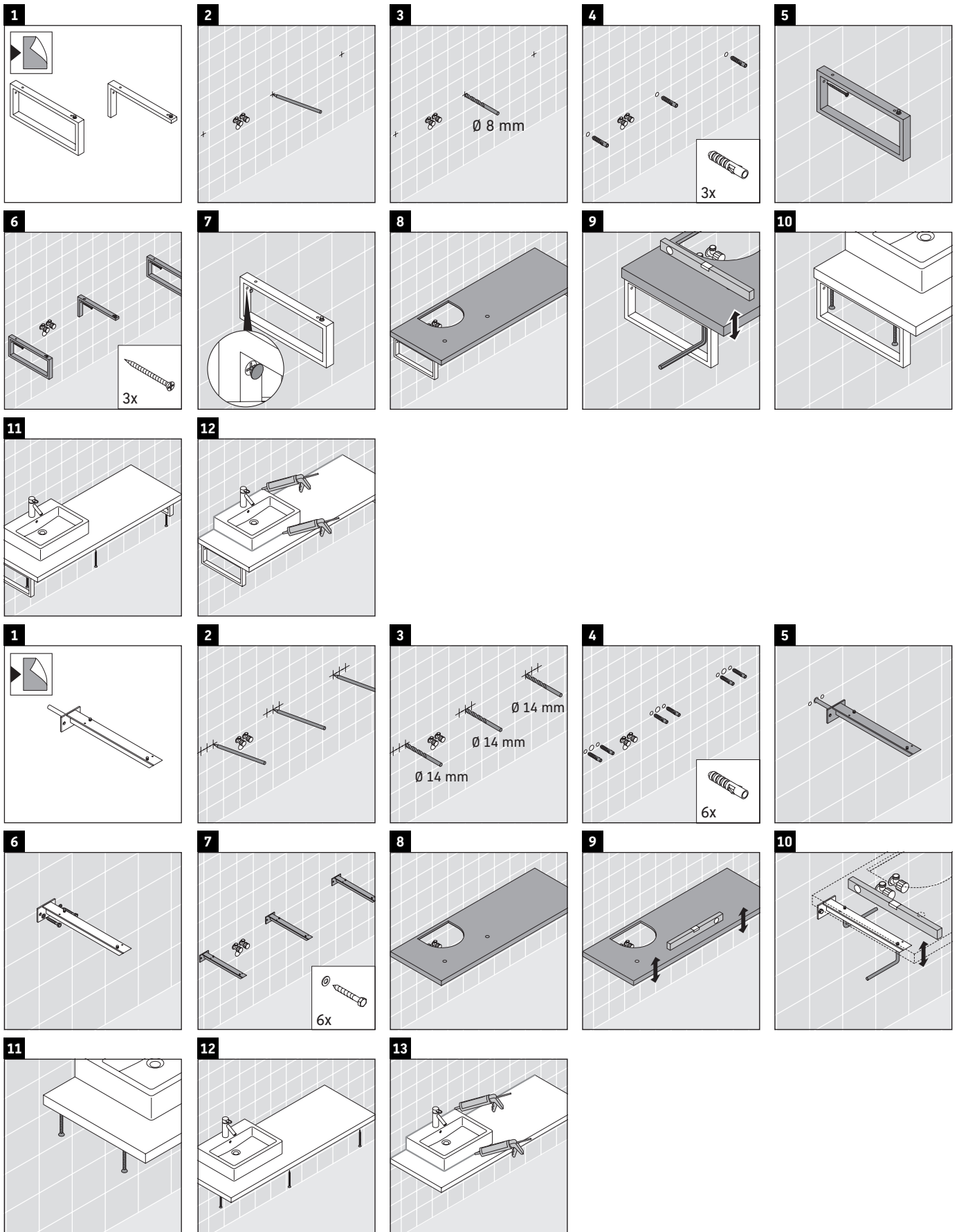

L-Cube

LC 106C

Mounting instructions

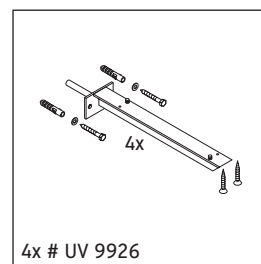
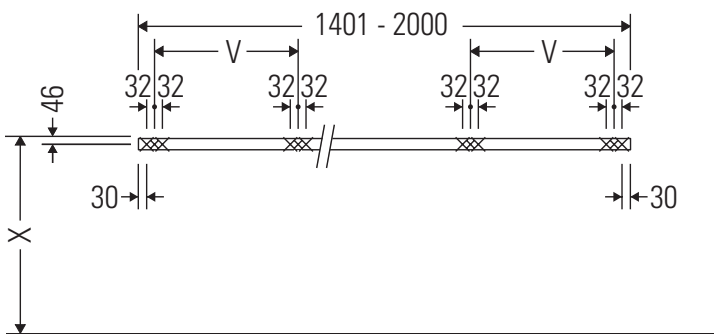
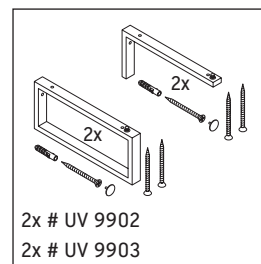
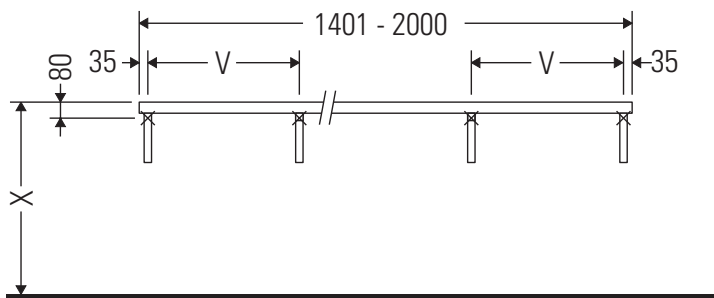
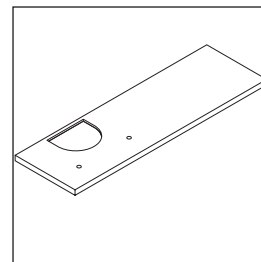
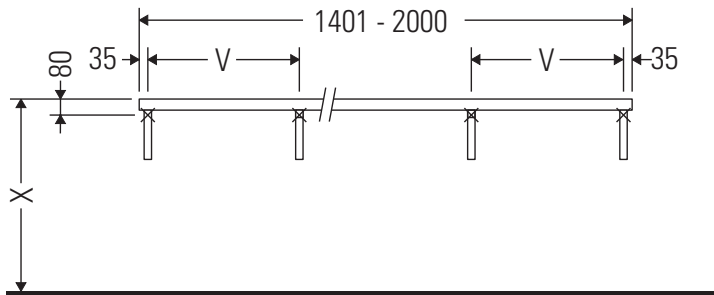

V = according to the panel specification



Follow all other installation instructions!

Instructions for use

The bathroom furniture range complies with the standards and guidelines applicable at the time of delivery and is designed for use in bathrooms.

Direct contact with water should be avoided, for example, when showering.

The console is not suitable for installation from below with semi built-in and built-in washbasins.

Ceramics wider than 600 mm must be fixed to the wall.

We reserve the right to make technical improvements and design modifications to the products illustrated.

