

# DuraStyle

# # DS 5308

## Mounting instructions

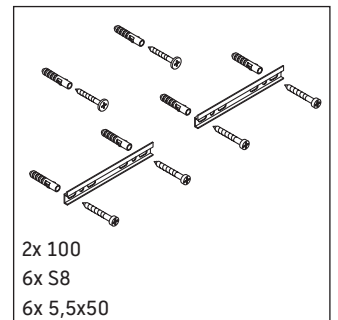
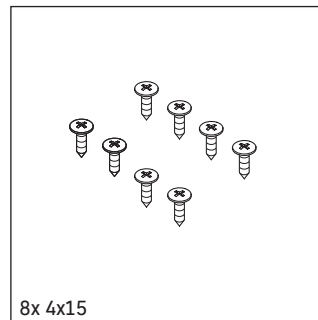
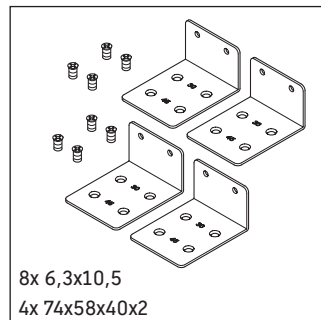
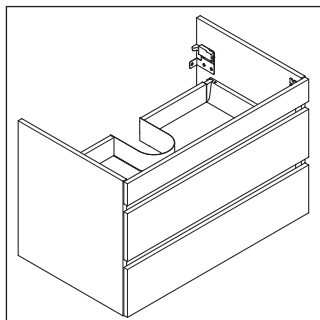
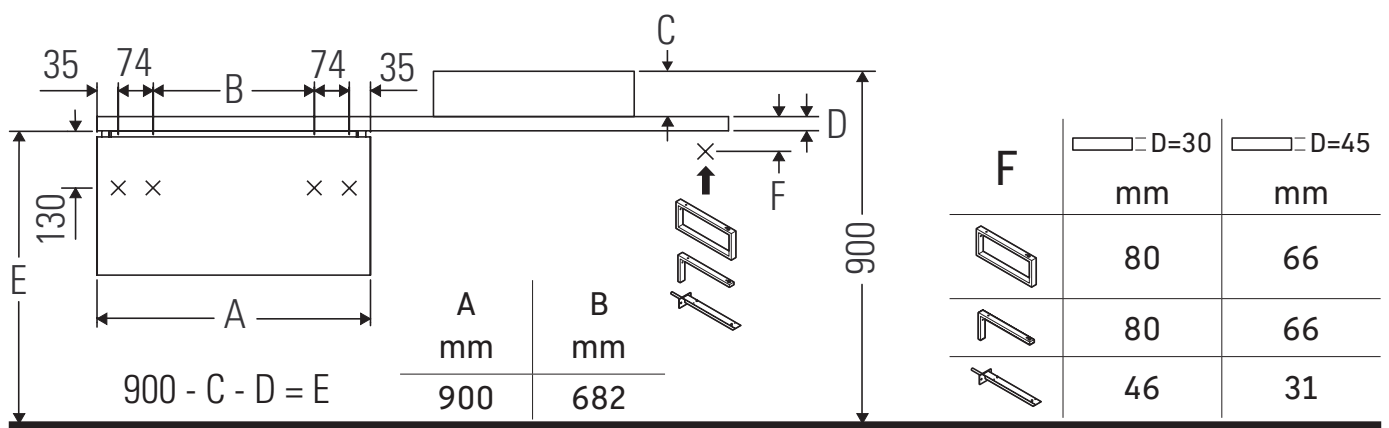

Observe the drilling dimensions!



Follow all other installation instructions!

### Instructions for use

The bathroom furniture range complies with the standards and guidelines applicable at the time of delivery and is designed for use in bathrooms.

Direct contact with water should be avoided, for example, when showering.

Ceramics wider than 600 mm must be fixed to the wall.

We reserve the right to make technical improvements and design modifications to the products illustrated.

